

Hamo

Cleaning Technology



T-BCC: Automated Washing & Drying System for IBCs, Drums, Pallets

Hamo
Cleaning Technology



Various Cleaning Applications

Usable Chamber Dimension

1500x1500x2000 mm

- IBC's 550L - 2,100L
- Drums 60L – 200L
- Aluminum Pallets
- Plastic Buckets
- Machine parts and accessories

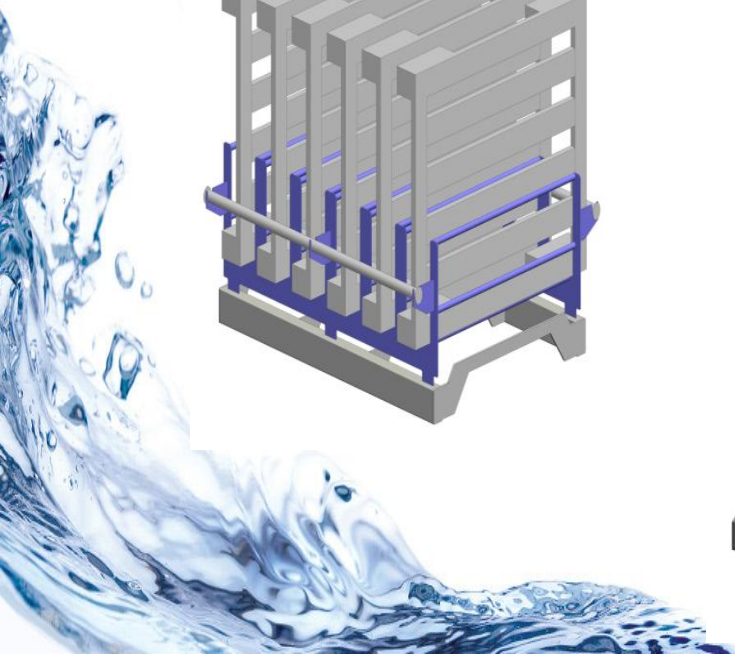
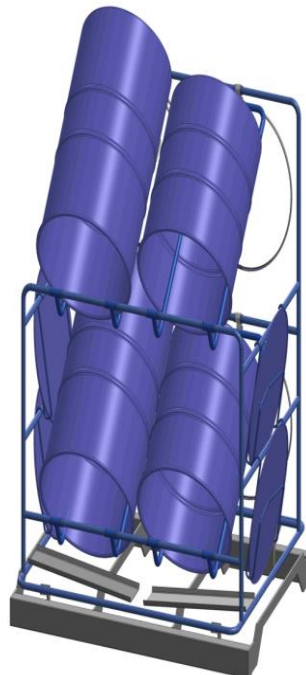
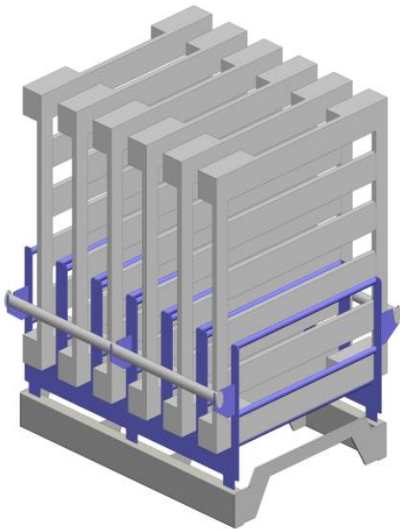
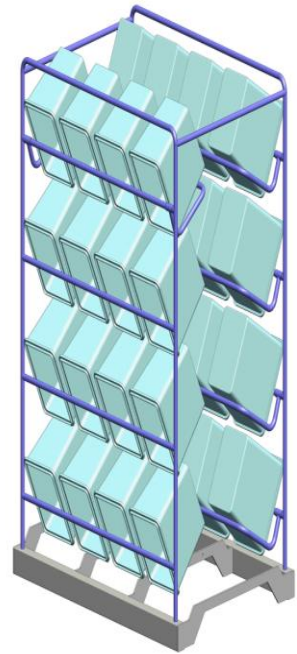
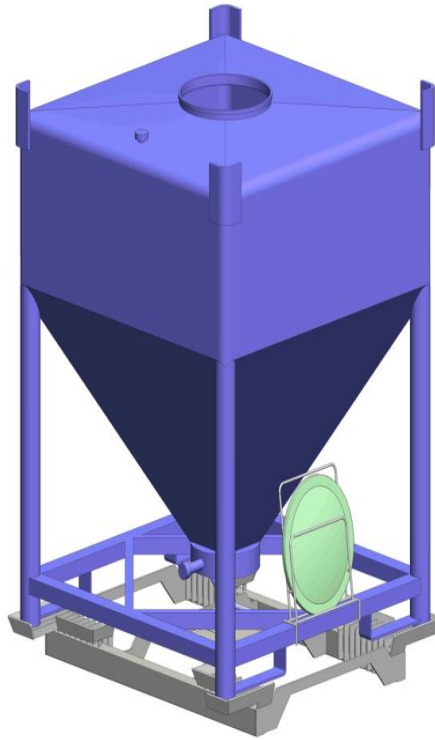

Two Chamber Washing and Drying

- Automatic sliding doors
- Inflatable door seals
- Completely welded chambers
- Cycle time: Approx. 15 to 20 minutes with cooling to 50°C.
- Water consumption approx. 600–800 L/cycle
- Washing lance for interior cleaning of IBC / Drums
- Rotating wash head for cleaning outlet flap of IBC
- Washing system for exterior of IBC, Drums, etc.

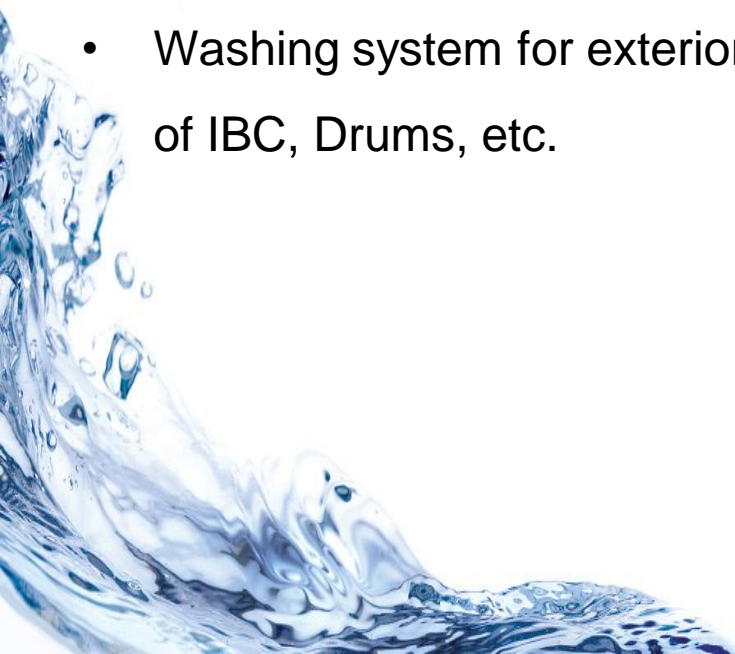

Specifications

- All wetted parts 316L SS
- cGMP Design
- FDA compliant components
- Load / Unload height 500 mm
- 3 digital detergent dosing systems
- Conductivity control for final rinse
- Hygienic circulation pump, heat exchanger, circulation piping
- HEPA filtered drying air
- Siemens S7-315 PLC controls
- HMI panel MP 377
- WinCC flexible architecture
- CFR21 part 11 compliant
- Optional Scada doc system

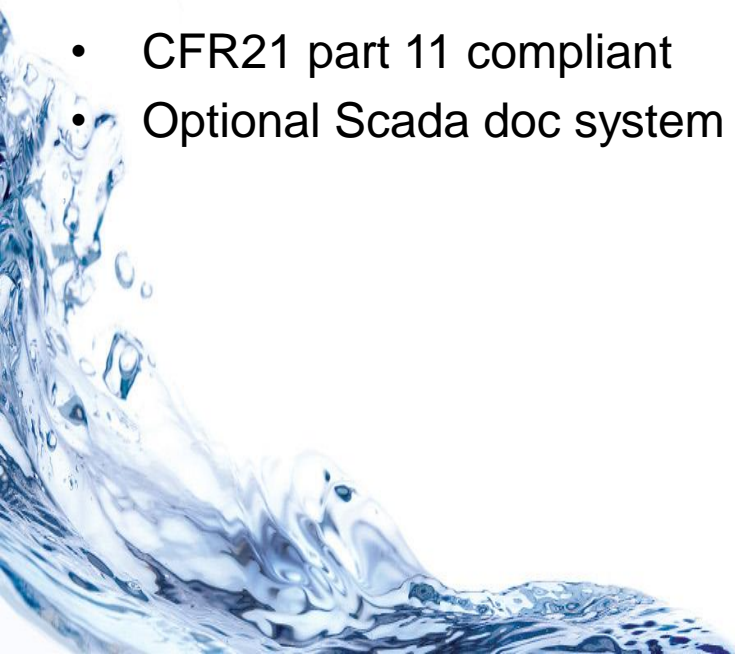

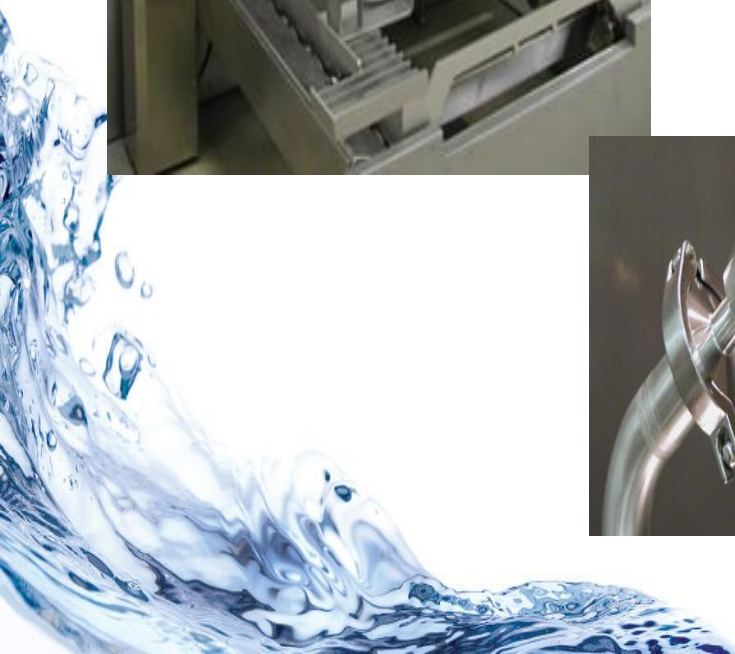
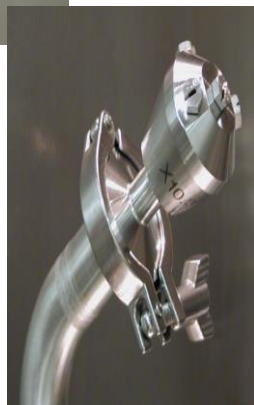

Amsonic - Hamo Group

World Headquarters

Amsonic AG
Zürichstrasse 3
2504 Biel, Switzerland
Phone +41 (0)32 344 35 00
Fax +41 (0)32 344 35 01
E-Mail amsonic.ch@amsonic.com

Germany

Amsonic Deutschland GmbH
Neckaraue 25
71686 Remseck / Stuttgart, Germany
Phone +49 (0)7146 280 81 0 Fax +49 (0)7146 280 81 10
E-Mail amsonic.de@amsonic.com

France

Amsonic France SAS
110, rue des frères Voisin,
Parc d'affaires de la Vallée de l'Ozon
69970 Chaponnay / Lyon, France
Phone +33 (0)437 28 18 00 Fax +33 (0)437 28 18 01
E-Mail amsonic.fr@amsonic.com

USA

Hamo USA Inc
500 Office Center Drive, Suite 400
Fort Washington, PA 19034
Phone : (855) GMP-WASH / (855) 467-9274
E-Mail hamo.us@hamo.com



Hamo
Cleaning Technology